

*the***ultimate**[®]
collection



PANORAMA

The Ultimate Aluminium Window & Door System



Welcome

PANORAMA aluminium windows and doors form part of the Ultimate Collection of products, a range of products designed with the emphasis on quality and performance.

We appreciate you are making a significant investment and you should therefore expect your new windows and doors to look beautiful, operate effortlessly and maintain these standards for years to come.

The PANORAMA range will be installed by a first-class installation team, and we are on hand to advise and guide you through the options, so you are able to make an informed choice.

This brochure is designed to both inform and inspire you. If you are considering aluminium windows and doors, we are confident that PANORAMA can offer a solution that will enhance your project.

Thank you for taking the time to learn more about PANORAMA, the Ultimate Aluminium Window and Door System.



WINDOWS



BI-FOLDING DOORS

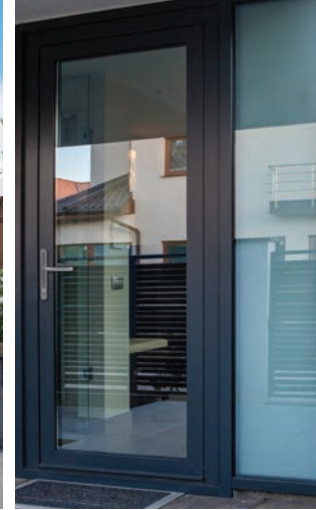

SINGLE DOORS



LIFT AND SLIDE PATIO DOORS

AESTHETICS

The slim sightlines and large glass areas achieved with PANORAMA aluminium, combine to provide a product that is perfectly suited to contemporary spaces. Equally as impressive whether viewed from the inside or outside of the property.

PERFORMANCE

PANORAMA products undergo stringent performance testing. Operation, strength, durability, acoustics, security, thermal performance and weather performance are amongst the many criteria tested.

10 YEAR GUARANTEE

PANORAMA windows and doors have a 10 Year Manufacturers Guarantee. This is your reassurance of the quality and durability of these highly specified products.

THERMAL EFFICIENCY

A combination of sophisticated aluminium chambered profile and high performance insulated glass sealed units used in PANORAMA windows and doors will help to preserve the heat in your home.

EASE OF OPERATION

PANORAMA products utilise slim aluminium frames and innovative hardware, resulting in windows and doors that operate smoothly and with little required force. Despite the slim appearance, the aluminium profile offers structural integrity and durability that will endure with only basic maintenance required.

SECURITY

For your reassurance PANORAMA windows and doors are rigorously tested to a high level of burglar resistance and include sophisticated built in security features that will provide confidence and peace of mind.

YOUR SAFETY

PANORAMA doors include safety glass as standard (in line with Building Regulation requirements) so in the unfortunate event of accidental glass breakage, the possibility of injury from sharp glass edges is reduced.

COLOUR & FINISH

We offer three colours as standard, White, Black and Anthracite Grey (same both internal and external) as well as an extended range of finishes (longer lead times may apply).

FINISH OPTIONS

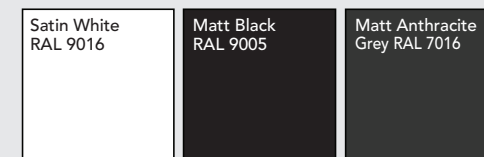

Extended Range

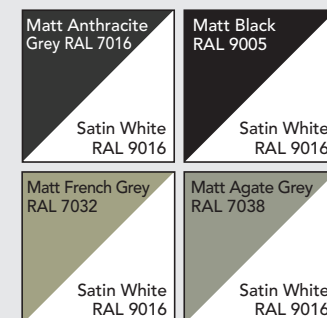

Due to possible variations in the printing process, please refer to physical colour swatches for an accurate representation of the above finish options.

SLIM FRAMES MAXIMISE LIGHT INTAKE

The PANORAMA slimline aluminium window has been designed specifically to meet the needs of UK households. This unique and expertly engineered window suite offers the discerning homeowner the perfect combination of exceptionally slim frames and the highest levels of performance.

With sleek, clean lines, these beautifully designed windows can transform the appearance of any home, adding value to the property whilst also making it warmer, brighter and more secure.

Perfectly complementing both contemporary and traditional styles of property, the PANORAMA window is stylish and timeless in its design.

With an impressive 65mm sash to frame width (depending on outer frame choice, PANORAMA's clean lines provide a stylish yet practical solution, mimicking the sight lines of original steel-framed windows. The frame depth of 68mm makes them perfect replacement windows to fit within the existing plaster lines.

Glazing can be from the inside or outside and is available in various thermal options, double or triple glazed up to a maximum depth of 36mm. Also available as a full flush casement for a more traditional look.



TRIED AND TESTED

The PANORAMA slimline window was designed by a highly experienced team of engineers in a purpose-built, world-class design and testing facility. This window has been put through the most stringent test regime, ensuring that it is one of the highest performing and most reliable window systems available.

- Premium quality materials
- Highest levels of performance
- Industry-leading weather resistance

WARM AND COSY

One of the most noticeable differences for many homeowners is how warm and cosy their home feels once their new windows and doors are in place. PANORAMA is designed to offer class-leading insulation levels without compromising on the appearance of the window.

The result is a window that will keep heat loss through the window to a minimum, withstand the worst that the British weather has to throw at it, and will help keep your energy bills down.

PEACE AND QUIET

Not only is the frame of the PANORAMA window designed to help eliminate unwanted noise, the system is also flexible enough to allow a glazed unit up to 36mm thick to be specified.

This makes it possible to incorporate fairly sophisticated acoustic glazing, which makes a huge difference if you live near a busy road, a railway or an airport.



SAFE AND SECURE

PANORAMA windows are designed and tested to the most stringent security standards.

Knowing that your window can be upgraded to achieve PAS24 (enhanced security standard) means you can rest assured that your home, your family and your prized possessions are as safe as can be from would-be intruders.

- One of the most secure windows available
- PAS24 (Optional Extra)
- Enhanced security with hinge-side security brackets
- Multi-point locking mechanism
- Lockable handle



Lockable handle

Available in:

- White
- Polished Chrome
- Satin Chrome
- Black
- Anthracite Grey





Choice of 3 Window Styles

- Available in a choice of Contemporary, Flush or Heritage Window styles
- Choice of glazing types, double 28mm or triple 36mm
- Weathertight gaskets
- Thermal break

Contemporary Window (Standard Outer Frame)



Technical Characteristics

Maximum vent height (mm)	Side hung	1500*
	Top hung	1470*
Maximum vent width (mm)	Side hung	738*
	Top hung	1300*
Maximum vent weight (kg)	Side hung	40
	Top hung	50
Minimum visible widths (mm) (outward opening window)	Frame	15 (Slim) 26 (Standard)
	Vent	50
Overall system depths (mm)	Frame	68
	Vent	68
Rebate height (mm)		18
Glass thickness (mm)		28 to 36
Glazing method		Dry glazing with EPDM
Thermal insulation		Omega-shaped fibreglass reinforced polyamide strips (32 mm)

* Depending on glass and overall vent weight

Performance

Thermal Insulation ¹ EN ISO 10077-2	Uf-value down to 2.5W/m ² K depending on the frame/vent combination and the glass thickness. Uw ≥ 1.56W/m ² K for a standard window section ²
U-value – triple glazed	Uw ≥ 1.2W/m ² K based on windows size and configuration as per BS EN 14351 ²
U-value – double glazed	Uw ≥ 1.4W/m ² K based on windows size and configuration as per BS EN 14351 ²
Window energy rating –	A
Acoustic performance ³ EN ISO 140-3; EN ISO 717-1	Rw (C; Ctr) = 36 (-1; -5) dB / 47 (-2; -7) dB, depending on glazing type
Air tightness, max. test pressure ⁴ EN 1026; EN 12207	600Pa (Class 4)
Water tightness ⁵ EN 1027; EN 12208	600Pa (9A) / >1050PA (E1050)
Wind load resistance, max. test pressure ⁶ EN 12211; EN 12210	2400Pa (E2400)
Wind load resistance to frame deflection ⁶ EN 12211; EN 12210	C (s1/3000)
Burglar resistance ⁷	PAS 24 (enhanced security standard) optional extra

Flush Window (Standard Outer Frame)



Heritage Window (Standard Outer Frame)



Notes

This table shows possible classes and values of performances. The values indicated in red are the ones relevant to this system.

¹ The Uf-value measures the heat flow. The lower the Uf-value, the better the thermal insulation of the frame.

² Window dimension 1.23m x 1.48m. DGU (Double Glazed Unit) Ug=1.0W/m²K, TGU (Triple Glazed Unit) Ug=0.8W/m²K.

³ The sound reduction index (Rw) measures the capacity of the sound reduction performance of the frame.

⁴ The air tightness test measures the volume of air that would pass through a closed window at a certain air pressure.

⁵ The water tightness testing involves applying a uniform water spray at increasing air pressure until water penetrates the window.

⁶ The wind load resistance is a measure of the profile's structural strength and is tested by applying increasing levels of air pressure to simulate the wind force.

There are up to five levels of wind resistance (1 to 5) and three deflection classes (A,B,C). The higher the number, the better the performance.

⁷ The burglar resistance is tested by static and dynamic loads, as well as by simulated attempts to break in using specified tools. This variant requires specific burglar resistance accessories.

BI-FOLD DOORS

Bi-fold doors, or folding sliding doors if you prefer, are a modern and innovative design statement that can transform an ordinary room and make it a feature of the house.

These doors can flood the room with natural daylight and open up the house to the garden, letting the outside in.

Bi-fold doors have been hugely popular in the UK for a number of years. The PANORAMA Bi-fold door benefits from years of experience, research and development.

The result is a stylish-looking product that combines industry-leading performance with smooth and reliable operation.

DESIGNED FOR MODERN DAY LIVING

Over time we have changed the way we use our homes. There has been a shift towards large open plan spaces, particularly with combined kitchen and dining areas where we spend so much of our time.

Equally, the distinction between indoor and outdoor living has become less defined with a common emphasis now placed on how the home flows from inside through to the garden.

Bi-fold doors are the perfect solution for those wishing to maintain the sense of light and space in the home and when the weather permits open up fully into the garden.

PANORAMA Bi-fold doors can be designed with up to 6 panes and in a variety of folding configurations. Should you want to, a single traffic door can be specified left or right to give access in and out without the need to open up the full width of the door.



INNOVATIVE FEATURES AND BENEFITS





- Slim frames providing maximum light
- Doors fold neatly to maximise opening
- Double or Triple glazed options
- Security to British and European standards
- 6 point lock as standard (optional hook lock: 2 hooks, 1 deadbolt and latch)
- Inward or outward opening
- Four threshold options
- Water resistance up to 600 Pa
- Up to 6 door leaves
- Maximum height 2412 mm
- Maximum door leaf width 1200 mm
- High spec stainless steel rollers
- Range of handle finish options
- 3 star high security Yale cylinder
- Sealed unit depths from 28-36 mm



Technical Characteristics

Variants		Flush threshold	Low threshold	Double weather seal	High performance
Visible width / height	Frame / threshold	0-15 mm	9-30 mm	23-44 mm	23-74 mm
	Frame-vent section	100 mm			
	Vent-vent section	131 mm			
Overall system depth		68 mm			
Maximum element height		2412 mm			
Maximum vent weight		120 kg			
Rebate height		14 mm			
Glass thickness		28-36 mm			
Glazing method		dry glazing with EPDM or neutral silicones			
Thermal insulation		23 mm, 27.5 mm and 32 mm fibreglass reinforced polyamide strips			
HI variant		extra insulation foams			

Performance

	Flush threshold	Low threshold	Double weather seal	High performance
Energy				
 Thermal insulation ⁽¹⁾ EN ISO 10077-2	Uf-value down to 1.8 W/m ² K ^(*) , depending on the profile combination			
Comfort				
 Air-tightness, max. test pressure ⁽²⁾ EN 12207	Not applicable	Class 4	Class 4	Class 4
 Water-tightness ⁽³⁾ EN 12208	Not applicable	Class 5A (200 Pa)	Class 7A (300 Pa)	Up to Class 9a (600 Pa)
 Wind load resistance ⁽⁴⁾ EN 12211; EN 12210	Not applicable	C1/B3	C2/B3	C2/B3
Safety				
 Burglar resistance ⁽⁵⁾ ENV 1627 - ENV 1630	Not applicable	RC2	RC2	RC2

This table shows classes and values of performance, which can be achieved for specific configurations and opening types.

⁽¹⁾ The Uf value measures the heat flow. The lower the Uf value, the better the thermal performance of the frame.

⁽²⁾ The air-tightness test measures the volume of air that would pass through a closed product at a certain air pressure.

⁽³⁾ The water-tightness test involves applying a uniform water spray at increasing air pressure until water penetrates the product.

⁽⁴⁾ The wind load resistance test is a measure of the profile's structural strength and involves applying increasing levels of air pressure to simulate wind force.

⁽⁵⁾ The burglar resistance is tested using static and dynamic loads, as well as simulated attempts to break in using specified tools. This variant requires specific burglar resistant accessories.

^(*) Please refer to Reynaers' CE passport for all technical data including size limitations.

^(†) Value for HI-variant.

HORIZONTAL CROSS-SECTION

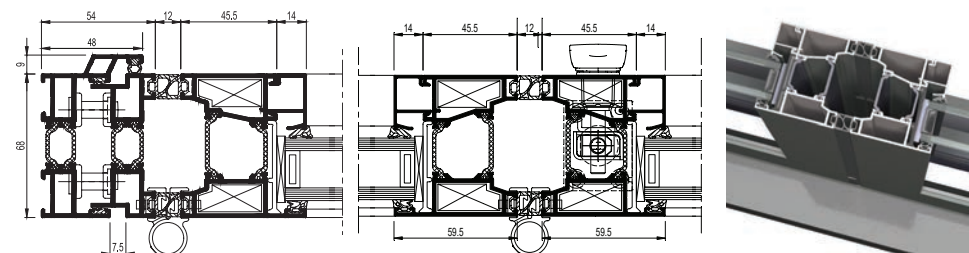

THRESHOLD OPTIONS

The CF 68 can be specified with any of our four different threshold options:

- Flush threshold (Level 1)
- Low threshold (Level 2)
- Double weather seal (Level 3)
- High performance (Level 4)

Each threshold option gives a trade-off between weather performance and ease of passage. The High Performance option offers the best air, wind and water performance but has the highest threshold step. The Double Weather Seal solution combines good weather resistance with a lower threshold.

The Low Threshold option can be set into the floor to meet the requirements of building regulations, and the Flush Threshold solution allows easy passage with no step at all, but this is at the expense of weather-proofing.

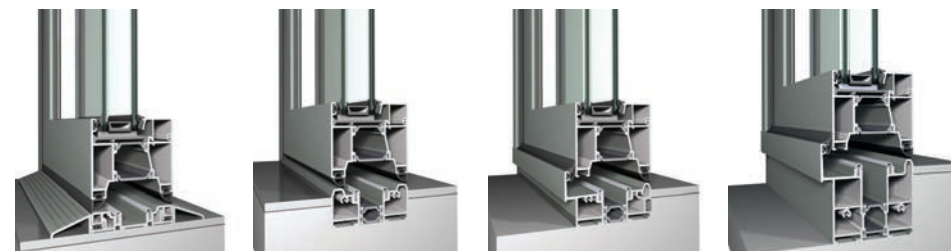

Level 1
Flush threshold

Level 2
Low threshold

Level 3
Double weather seal

Level 4
High Performance

VERSATILE DESIGN OPTIONS

Available in a number of configurations using up to 6 door leaves, you can specify a design where all the door leaves stack to the same side, or a design where some stack one way and some the other.

Choose whether you want the doors to open in or out, and remember that designs with a single traffic door enable you to slip quickly and easily into the garden, while leaving the other doors in place.

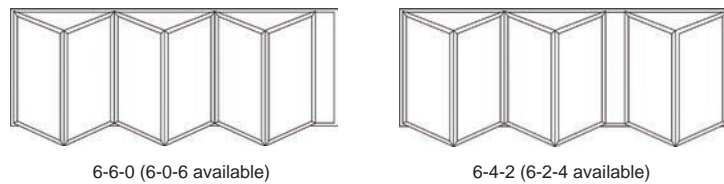
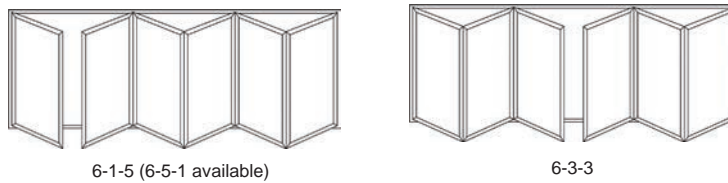
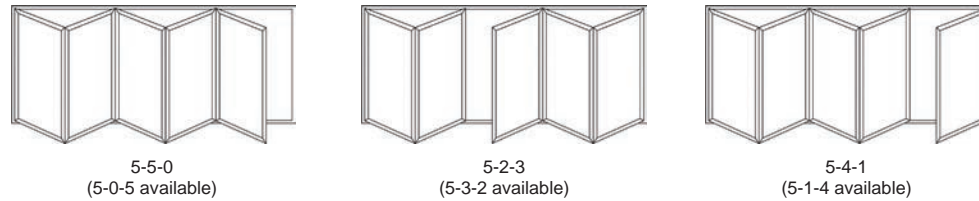
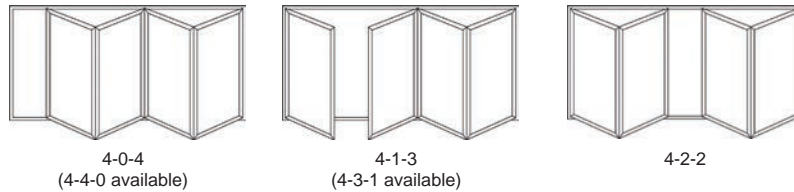
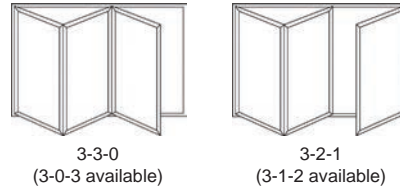
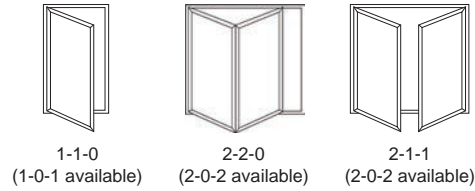

STANDARD HANDLE OPTIONS

The Standard Bi-Fold Handles are available in 5 colour finishes, all with intermediate door handles to match.



White



Polished Chrome



Satin Chrome



Anthracite Grey



Black

High Security Cylinder

To prevent cylinder manipulation, Ultimate doors are fitted with a 3 star high security Yale cylinder, and for convenience all doors are supplied with 3 keys as standard.



the **ultimate**[®]
collection

Partnership secured with **Yale**[®]



White



Polished Chrome



Satin Chrome



Anthracite Grey



Black



Open & Close function
and key storage



Centrefold D-Handles
available in White, Black
or Anthracite Grey

LETTING THE OUTSIDE IN WITH LIFT AND SLIDE DOORS

A sliding door opens up a multitude of possibilities. Open this door just a few centimetres for a little fresh air, a little wider to slip out into the garden or open it all the way to really let the outside in.

This versatile door creates an extra feeling of space and generates more natural light within the home.

DURABILITY

The PANORAMA lift and slide door uses durable, stainless steel wheels and rails for ease of operation. The sliding door is lifted slightly before opening or closing.

This reduces the friction and makes the operation smooth and effortless. In the closed position, the lift and slide door is lowered onto the track, providing additional weather resistance.

SMOOTH OPERATION

PANORAMA is a premium insulated sliding door system combining high weather performance with enhanced security and great aesthetics. With a lift and slide mechanism, this sliding door system is designed with ease of use in mind.

The system not only glides smoothly, it also has a slimline mid-section interlock to maximise the glass area. With a maximum vent weight of 300 kg and a maximum height of 2.5 m, this versatile system is ideal for most residential applications.

Thermal insulation is important for most people. PANORAMA doors offer industry-leading performance in this respect.



PRODUCT SPECIFICATIONS

- Satin White Ral 9016, Matt Black Ral 9005 or Matt Anthracite Grey Ral 7016 finish options (see page 3 for additional options on extended lead times)
- Lift and slide operation
- Effortless operation with up to 300kg maximum vent weight
- 4 point locking system
- 10 Year Guarantee
- Stainless steel rollers
- Anti-stick Teflon coated gaskets
- Slimline mid-section interlock
- Twin or Triple track sliding options
- Sealed unit depths from 28-36 mm



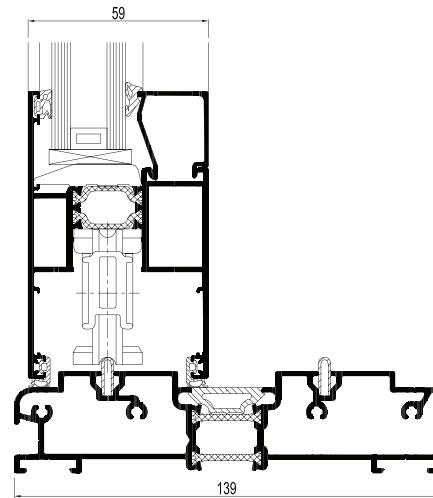

Flush floor integration

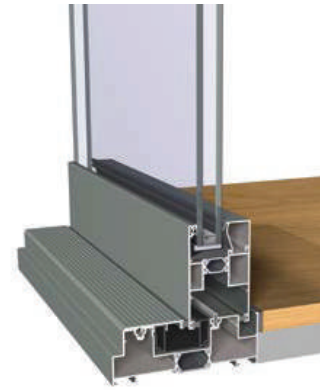

Slim Line middle section

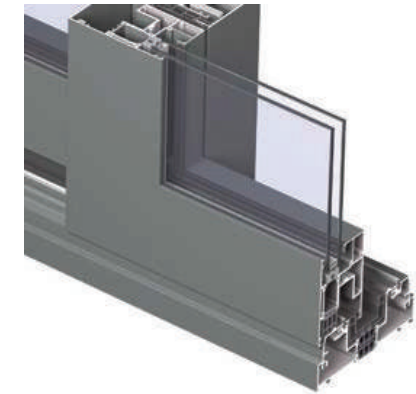

Technical Characteristics

Variants		CP 130-LS Twin track and triple Track
Visible width / height	Frame / Threshold	28mm Threshold / 35mm Jamb / 40mm Head
	Vent	94 mm
	T-profile	from 76 mm to 154 mm
	Meeting section	69 / 98 mm
	Meeting section 4 doors	194 mm
Overall system depth	Frame	Twin Track: 139 mm Triple track: 210 mm
	Vent	59 mm
Maximum element height		2500 mm
Maximum vent weight		300 kg
Rebate height		25 mm
Glass thickness		28-36 mm
Glazing method		Dry glazing with EPDM or neutral silicones
Thermal insulation		23 mm and 32 mm fibreglass reinforced polyamide strips
HI variant		extra insulation gaskets

Performance

Energy				
	Thermal Insulation ⁽¹⁾ EN 10077-2	Uf-value down to 2.35 W/m ² K, depending on the frame/vent combination		
Comfort				
	Acoustic performance ⁽²⁾ EN ISO 140-3; EN ISO 717-1	Rw (C; Ctr) = 35 (-2;-6) dB / 39 (-1;-3) dB, depending on glazing type		
	Air-tightness, max. test pressure ⁽³⁾ EN 12207	4 (600 Pa)		
	Water-tightness (Design Dependent) ⁽⁴⁾ EN 12208	7A (300 Pa)	8A (450 Pa)	9A (600 Pa)
	Wind load resistance, max. test pressure (Design Dependent) ⁽⁵⁾ EN 12211; EN 12210	2 (800 Pa)	3 (1200 Pa)	4 (1600 Pa)
	Wind load resistance to frame deflection ⁽⁵⁾ EN 12211; EN 12210	B (≤ 1/200 Pa)		C (≤ 1/300 Pa)
Safety				
	Burglar resistance ⁽⁶⁾ ENV 1627 – ENV 1630	RC 2		

This table shows classes and values of performance, which can be achieved for specific configurations and opening types.

⁽¹⁾ The Uf-value measures the heat flow. The lower the Uf-value, the better the thermal insulation of the frame.

⁽²⁾ This table shows classes and values of performances which can be achieved for specific configurations and opening types.

⁽³⁾ The air-tightness test measures the volume of air that would pass through a closed product at a certain air pressure.

⁽⁴⁾ The water-tightness test involves applying a uniform water spray at increasing air pressure until water penetrates the product.

⁽⁵⁾ The wind load resistance is a measure of the profile's structural strength and is tested by applying increasing levels of air pressure to simulate the wind force.

⁽⁶⁾ The burglar resistance is tested by static and dynamic loads, as well as by simulated attempts to break in using specified tools. This variant requires specific burglar resistance accessories.

LIFT & SLIDE DOOR CONFIGURATIONS

Choose from a twin track or triple track system, depending on the width of the opening and your preferred configuration of fixed panes and sliding doors.

TWIN TRACK OPENING CONFIGURATIONS

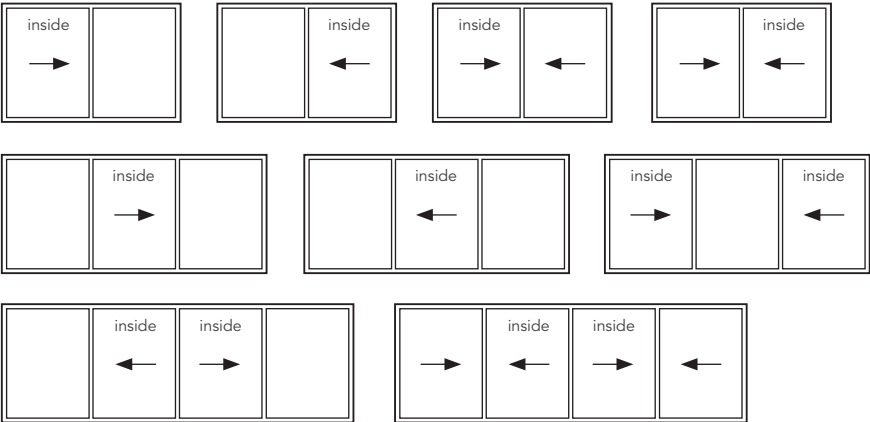

TRIPLE TRACK OPENING CONFIGURATIONS

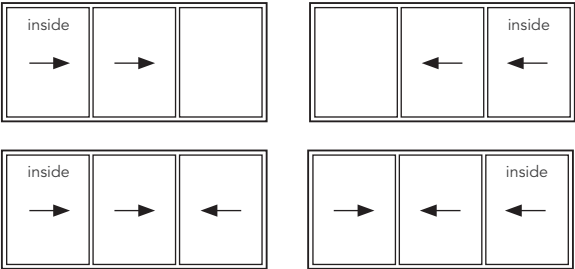

*'inside' denotes slider on internal track



STANDARD HANDLE OPTIONS

Our Lift and Slide Patio Door handles are available in the same 5 colour finishes, with finger pull cups to match:



White



Polished
Stainless Steel



Satin Chrome



Anthracite Grey



Black



White



Polished
Stainless Steel



Satin Chrome



Anthracite Grey



Black





ISO 9001:2015
FM 33147



BS EN1279 PT2

KM 37462
AG Glass



Ultimate products are put through regular stringent tests to ensure a consistent high level of quality, but don't just take our word for it...

The British Standards Kitemark is one of the most well known and respected product certification marks in the world and is your reassurance that BSI has checked that your Ultimate products comply with the latest British Standard.

Quality Assurance ISO 9001:2015

This certification was awarded for providing a high level of Quality Control systems throughout manufacture, administration, health & safety, and products including that of our suppliers such as profile and hardware. We are required to give BSI unrestricted access to our offices and factories and allow random samples to be selected for testing on a regular basis.

BS EN1279 PT2. Sealed Units

A thorough and daily test routine for double glazed sealed units is carried out to ensure certification. Tests prove that sealed units adhere to correct dew point, sealant correctness and desiccant moisture absorbency.

BFRC. Product Energy Ratings

Products are assessed using specific glazing and given a rating for energy efficiency. You will be reassured to know that PANORAMA products meet the latest domestic replacement building regulations.





In keeping with market trends and improvements we reserve the right to change specifications accordingly and without notice.
Hardware, furniture and glass options may vary from those shown on images used at the time of print. Published by John Fredericks Plastics February 2023.

*the***ultimate**[®]
collection



www.theultimatecollection.uk